

Simulation Report

仿真条件

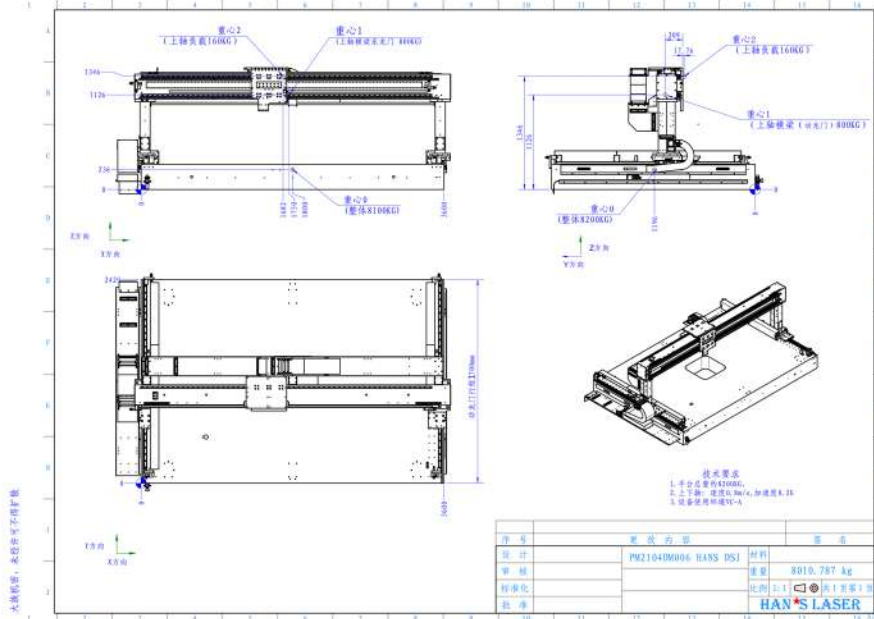

所选减振器: THS1-3000Z20-4-P3

Summary

Transmissibility

	X-Axis	Y-Axis	Z-Axis
Resonance Frequency	3.4Hz	3.4Hz	4.5Hz

Settling Time

		X-axis moving		Y-axis moving		X&Y axis moving	
		time(sec.)	Disp.	time(sec.)	Disp.	time(sec.)	Disp.
4 isolators	Stage stop (sec)	4.46	/	2.835	/	4.46	/
	Peak displacement (mm)	4.124	-0.147mm	2.550	-0.705mm	2.560	-0.795mm
	Specification (±0.01mm)	5.995	-0.01mm	6.124	-0.01mm	6.693	-0.01mm
	Settling time (sec)	1.535	/	3.289	/	2.233	/
6 isolators	Stage stop (sec)	4.46	/	2.835	/	4.46	/
	Peak displacement (mm)	4.139	-0.175mm	2.576	0.745mm	2.565	-0.801mm
	Specification (±0.01mm)	5.513	-0.01mm	6.123	-0.01mm	6.299	-0.01mm
	Settling time (sec)	1.053	/	3.288	/	1.839	/

Simulation Results

Transmissibility

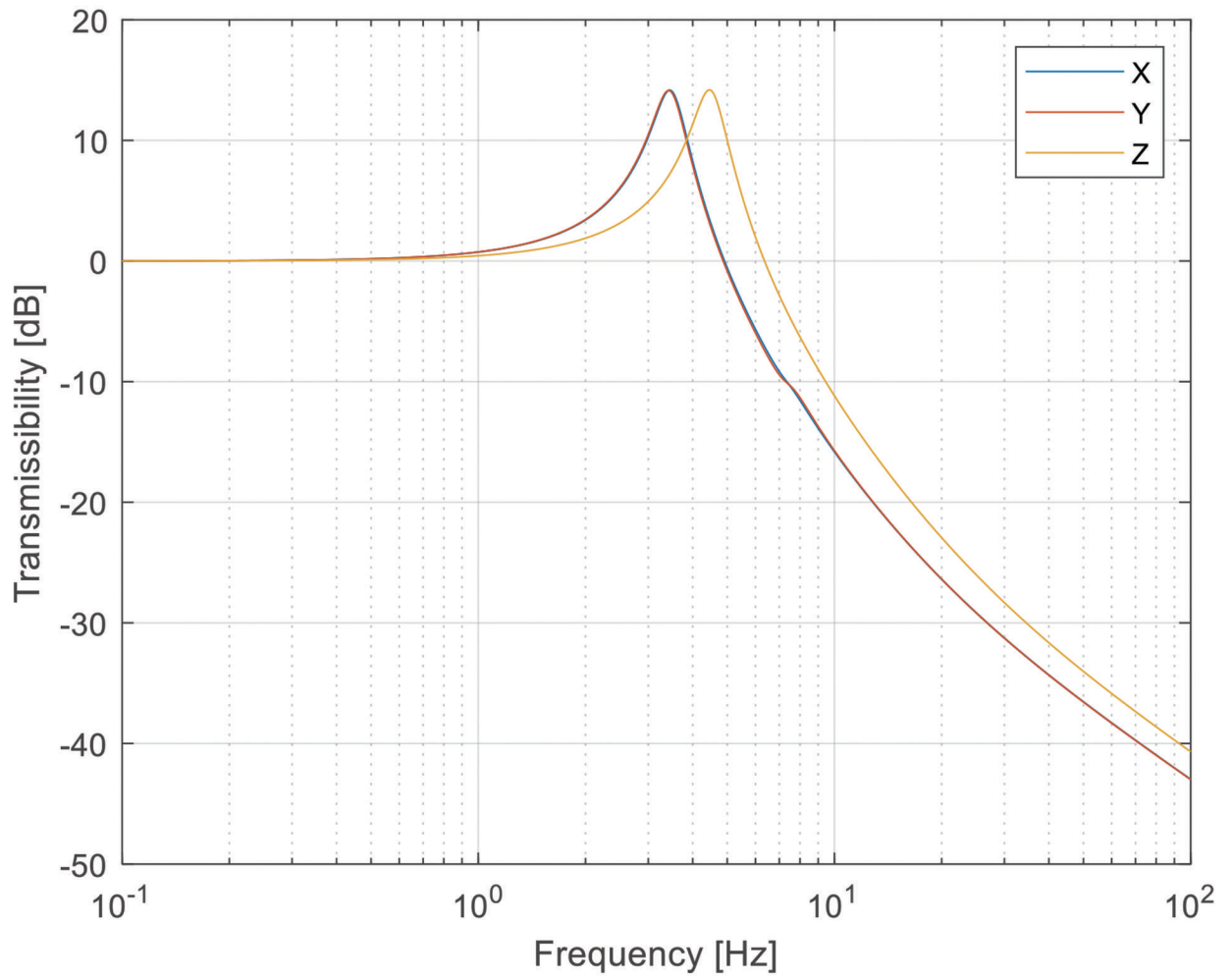

4 isolators

Displacement, X-AXIS MOVING

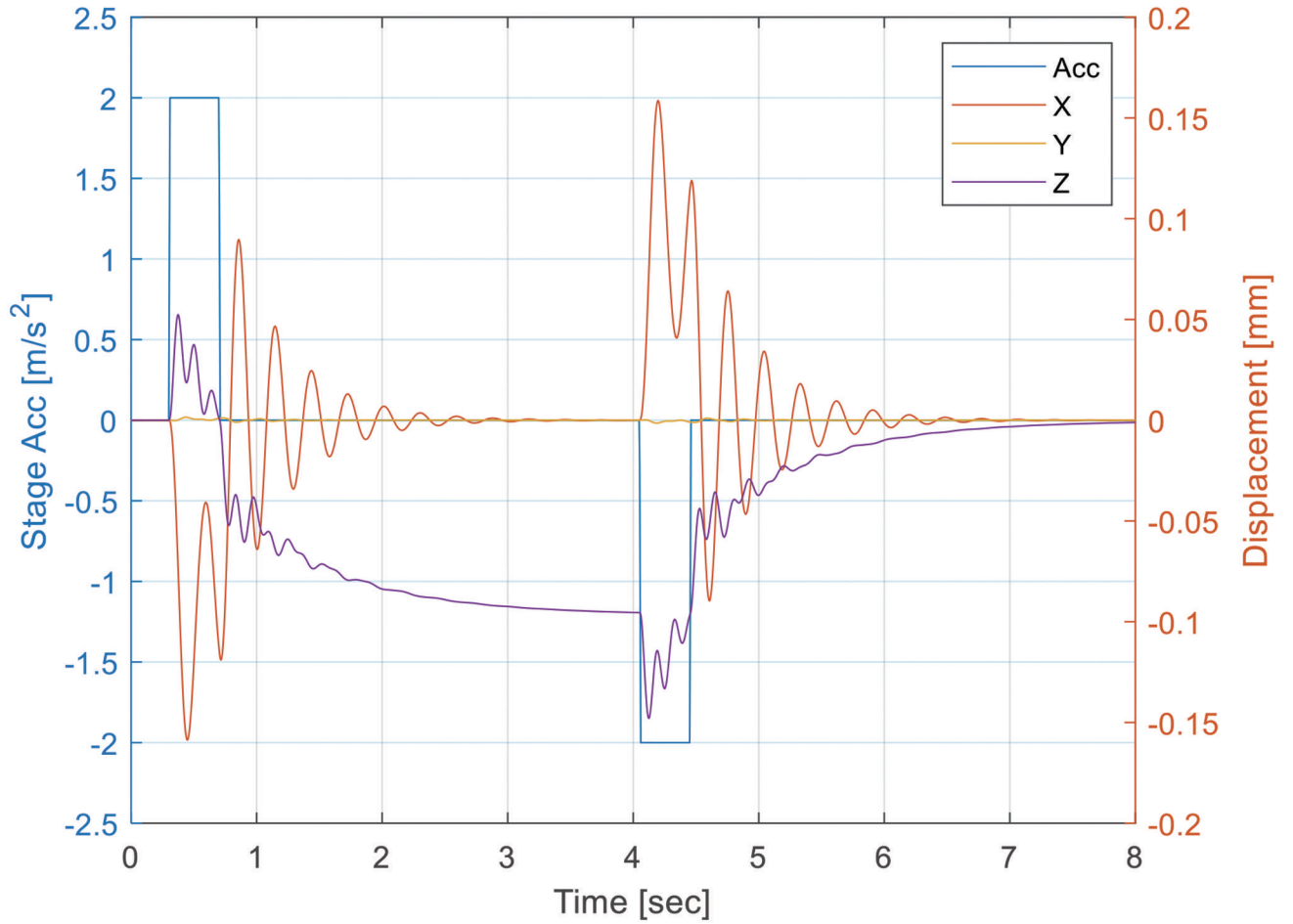

Displacement, Y-AXIS MOVING

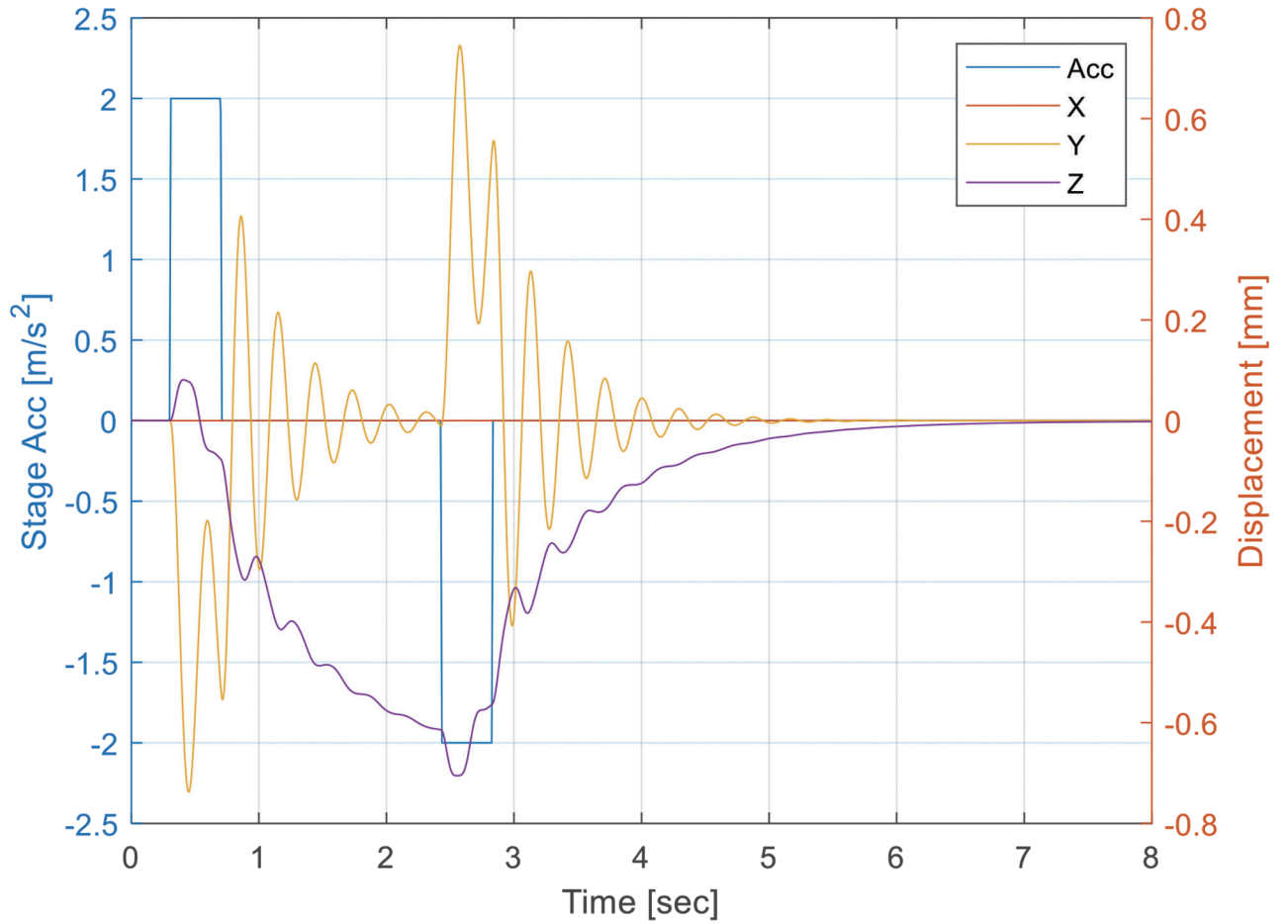

Displacement, X&Y-AXIS MOVING

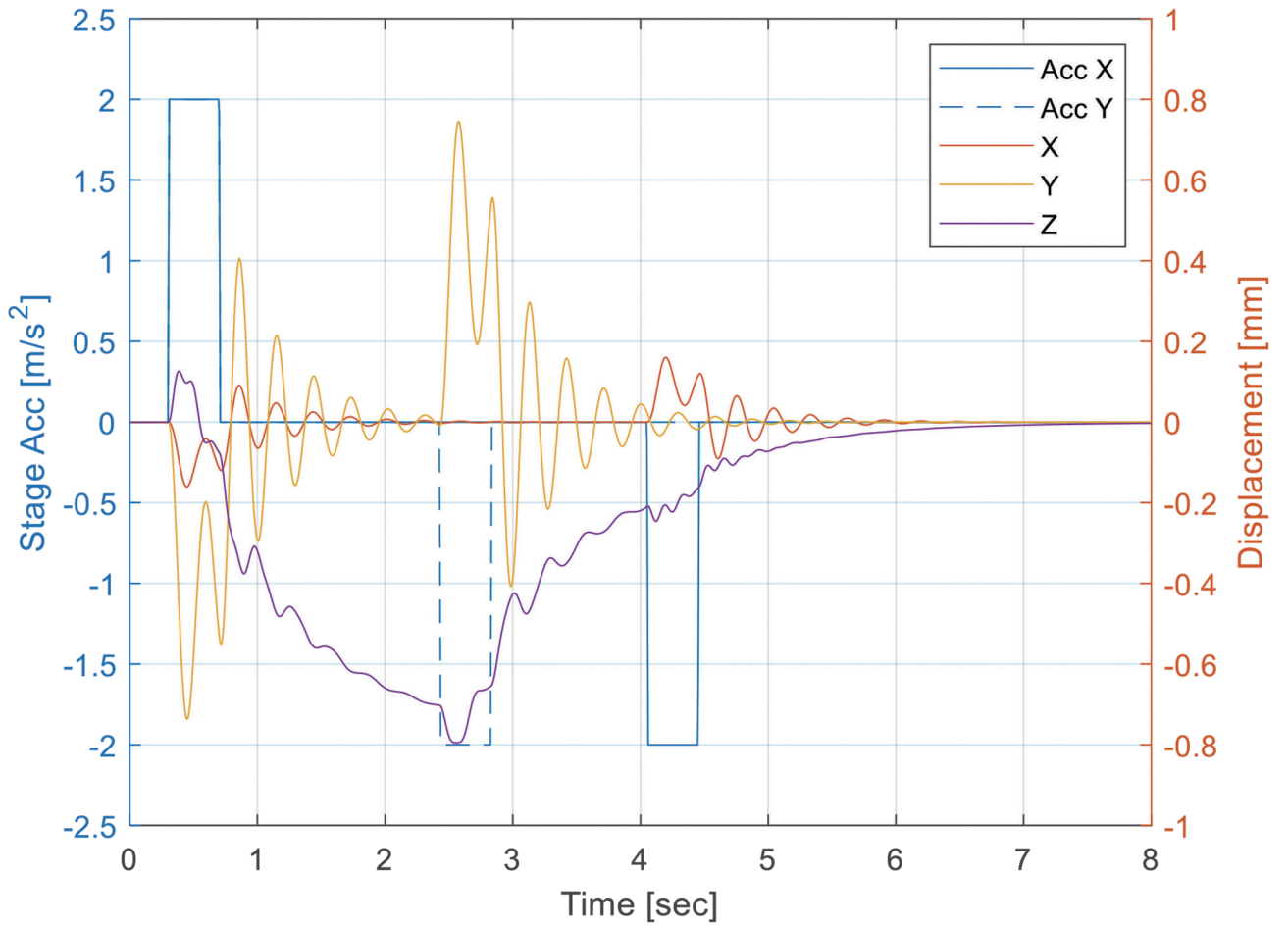

6 isolators

Displacement, X-AXIS MOVING

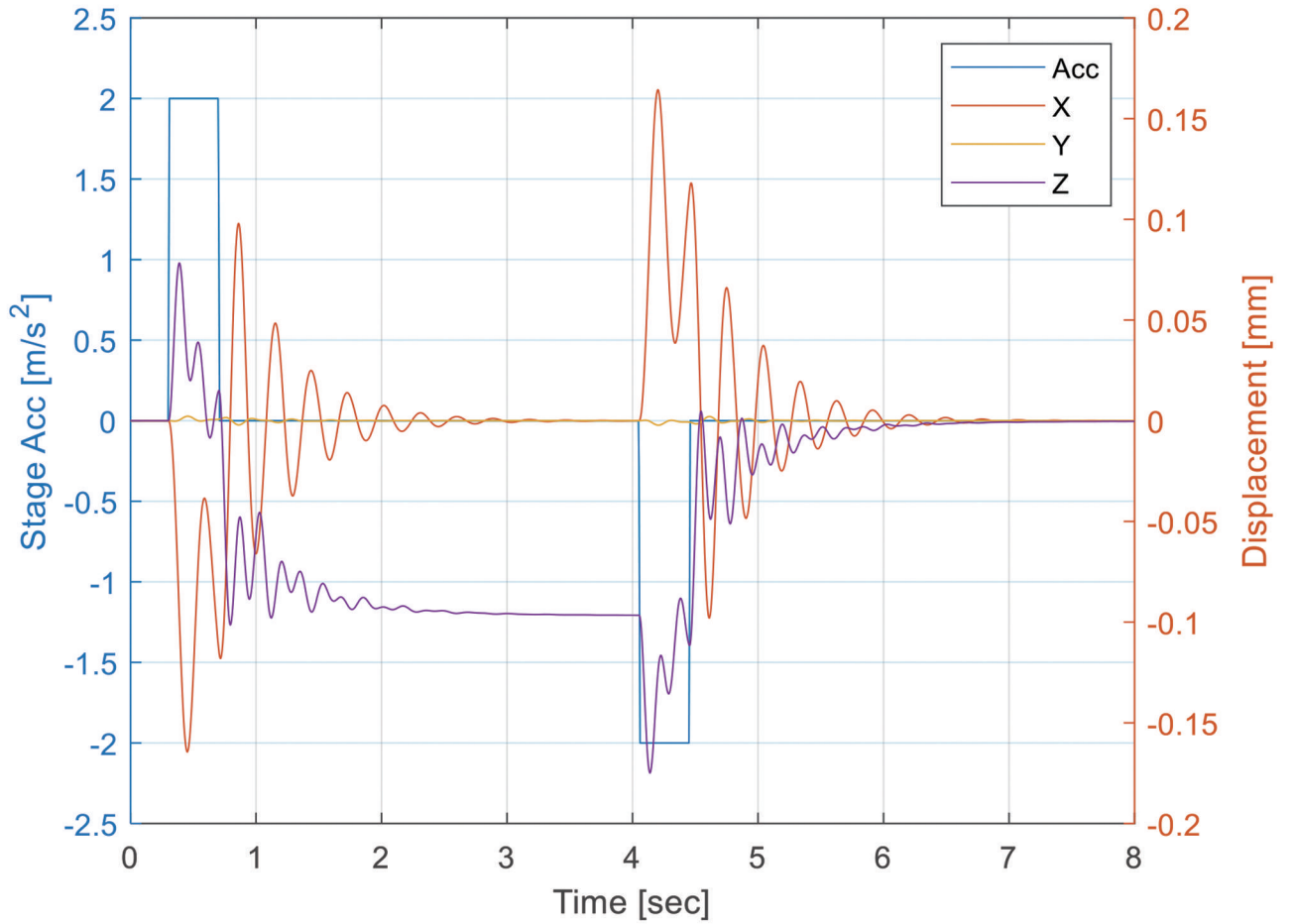

Displacement, Y-AXIS MOVING

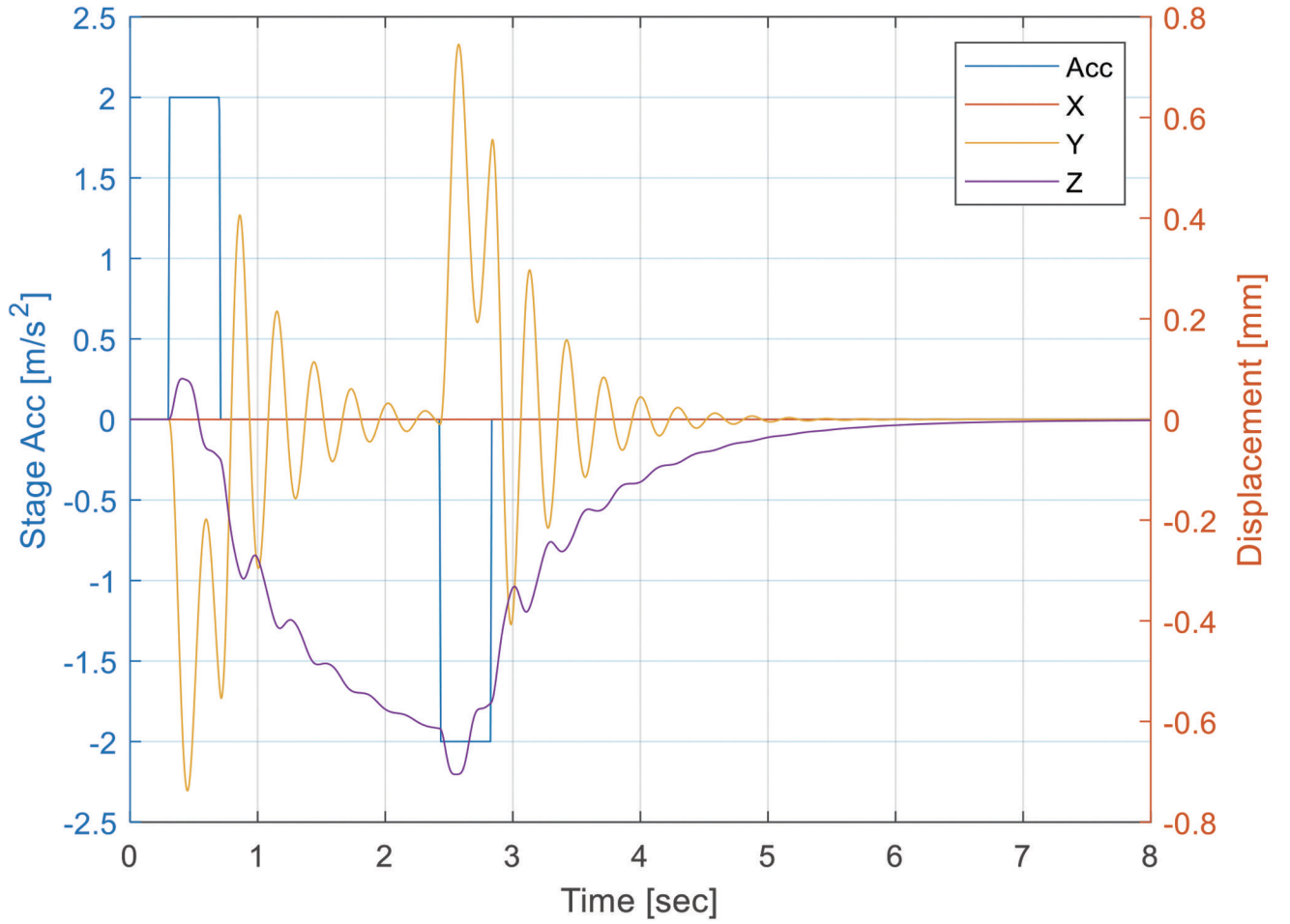

Displacement, X&Y-AXIS MOVING

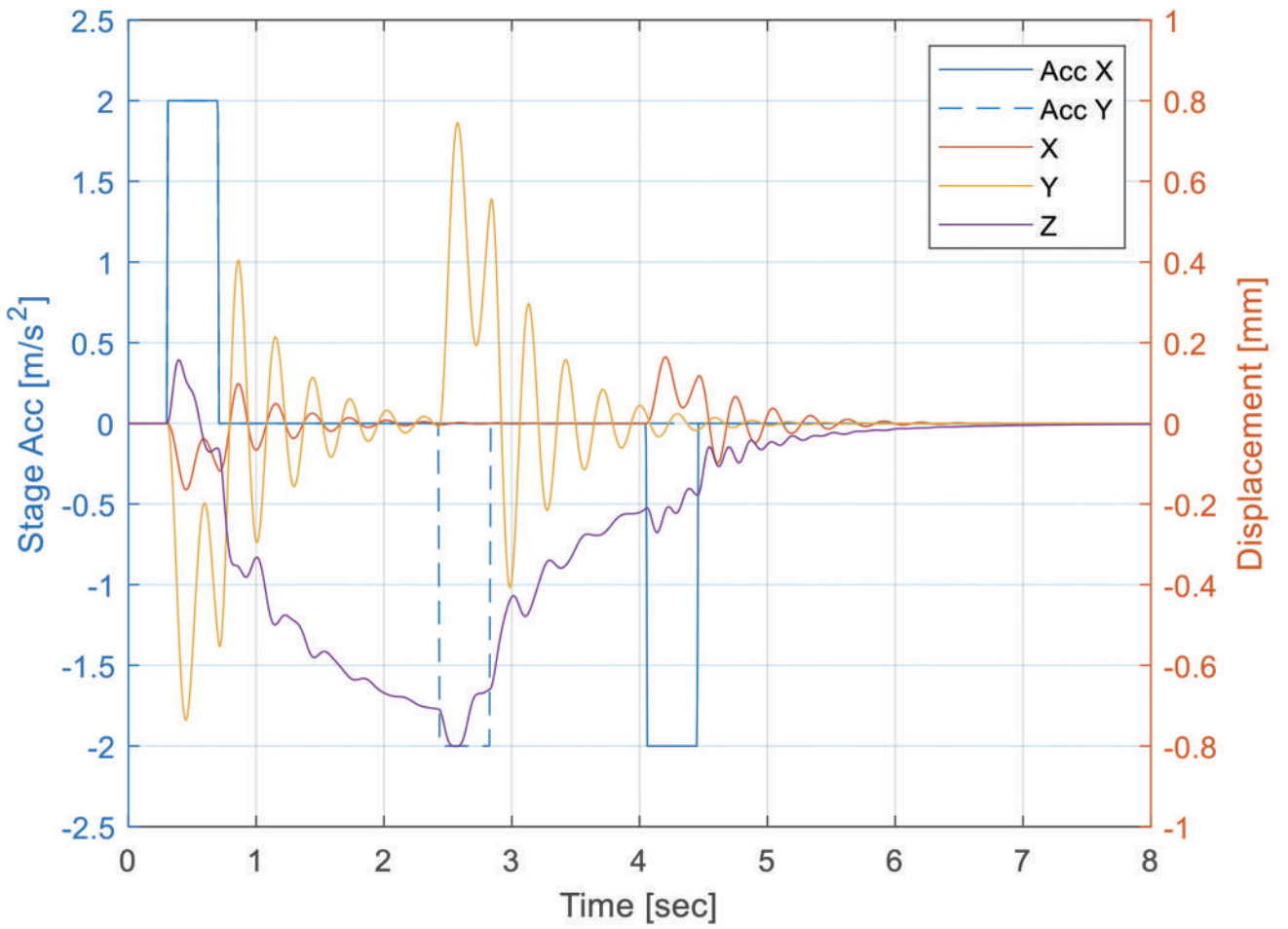

Profile, X-AXIS

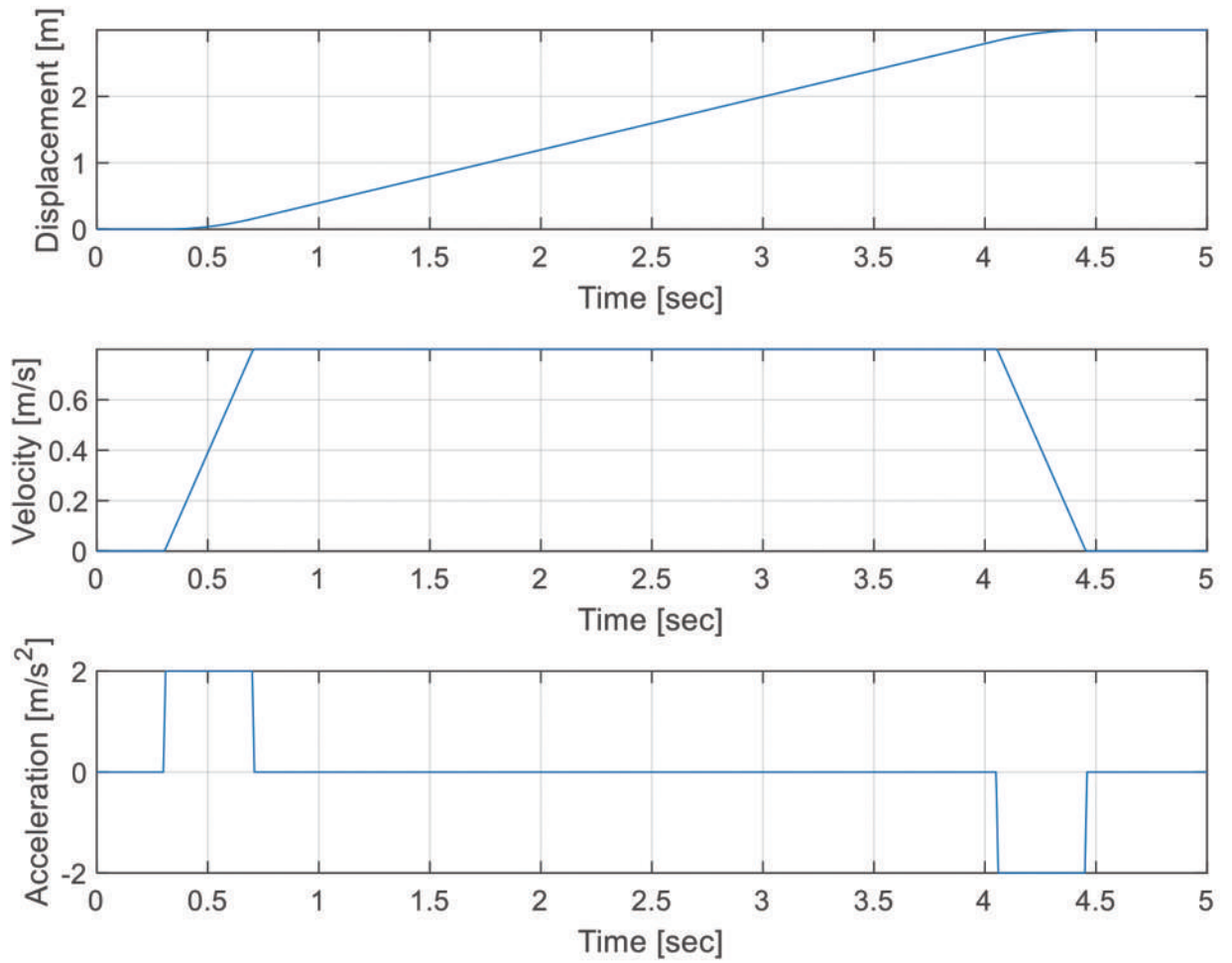

Profile, Y-AXIS

